

# COMPRESSED AIR TREATMENT

- Basic Principals
- Air Filters
- Cyclone Separators
- Refrigeration Dryers
- Adsorption Dryers
- Air Receiver Tanks
- Condensate Drains
- Oil / Water Separators
- Industrial Chillers
- EPL Piping System





## Compressed air quality classes according to ISO 8573-1:2010

CLASS	SOLID PARTICLES MAXIMUM NUMBER OF PARTICLES PER CUBIC METER AS A FUNCTION OF PARTICLE SIZE, D <sup>21</sup>			HUMIDITY AND LIQUID WATER PRESSURE DEW POINT		OIL CONCENTRATION OF TOTAL OIL <sup>21</sup> (LIQUID, AEROSOL AND VAPOUR)	
	[0.1 µm < d ≤ 0.5 µm]	[0.5 µm < d ≤ 1.0 µm]	[1.0 µm < d ≤ 5.0 µm]	[°C]	[°F]	[mg/m <sup>3</sup> ]	[ppm / w / w]
0	As specified by the equipment user or supplier and more stringent than class <sup>11</sup>						
1	≤ 20,000	≤ 400	≤ 10	≤ -70	-94	≤ 0.01	≤ 0.008
2	≤ 400,000	≤ 6,000	≤ 100	≤ -40	-40	≤ 0.1	≤ 0.08
3	Not specified	≤ 90,000	≤ 1,000	≤ -20	-4	≤ 1	≤ 0.8
4	Not specified	Not specified	≤ 10,000	≤ +3	38	≤ 5	≤ 4
5	Not specified	Not specified	≤ 100,000	≤ +7	45	Not specified	Not specified
6				≤ ±10	50		
	MASS CONCENTRATION <sup>21</sup> - C <sub>p</sub> [mg/m <sup>3</sup> ]			LIQUID WATER CONTENT <sup>21</sup> - C <sub>w</sub> [g/m <sup>3</sup> ]			
6	0 < C <sub>p</sub> ≤ 5			Not specified			
7	5 < C <sub>p</sub> ≤ 10			C <sub>w</sub> ≤ 0.5			
8	Not specified			0.5 ≤ C <sub>w</sub> ≤ 5			
9	Not specified			Not specified			
X	C <sub>p</sub> > 10			> 5			

<sup>11</sup> To qualify for a class designation, each size range and particle number within a class shall be met.

<sup>21</sup> At reference conditions: air temperature of 20° C, absolute air pressure of 100 kPa (1 bar), 0 relative water vapour pressure.

# BASIC PRINCIPLES OF MOST TYPICAL COMPRESSED AIR APPLICATION

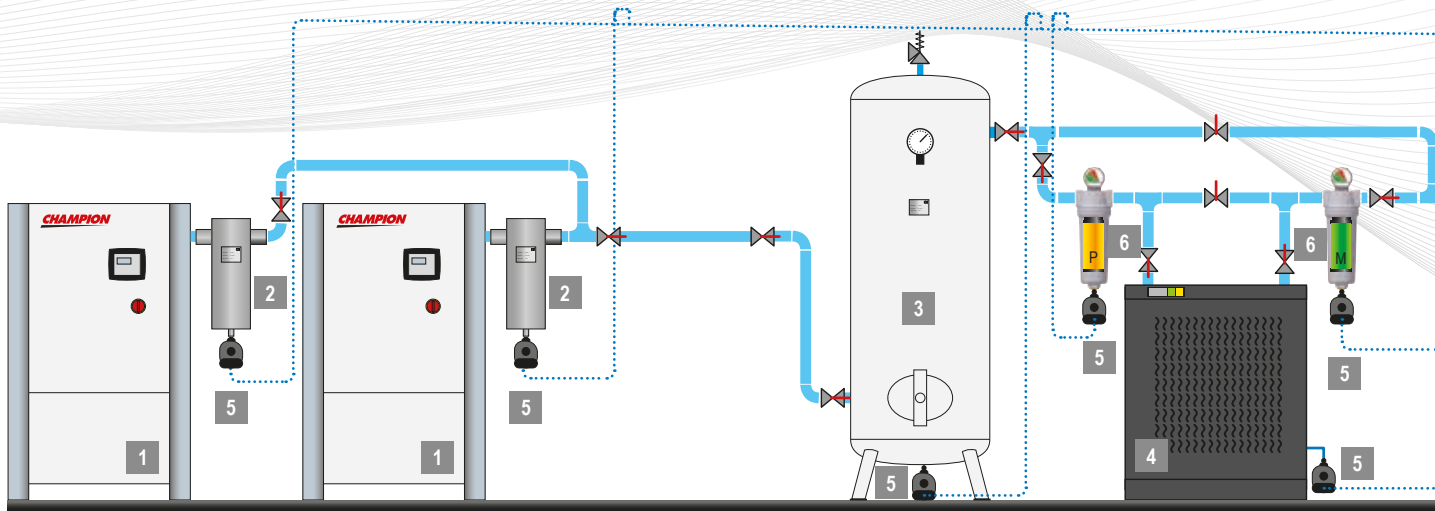

**1. Compressor:** The basic working principle of an air compressor is to compress atmospheric air, which is then used as per the requirements. In the process, atmospheric air is drawn in through an intake valve; more and more air is pulled inside a limited space mechanically by means of piston, impeller, or vane. Since the amount of pulled atmospheric air is increased in the receiver or storage tank, volume is reduced and pressure is raised automatically. In simpler terms, free or atmospheric air is compressed after reducing its volume and at the same time, increasing its pressure. Champion can provide many types of compressor to suit your needs.

**2. Cyclone condensate separator:** Cyclone condensate separators use centrifugal motion to force liquid water out of compressed air. The spinning causes the condensate to join together on the centrifugal separators walls when the condensate gains enough mass it falls to the bottom of the separators bowl where it pools in the sump until it is flushed out of the system by the automatic float drain valve. They are installed following aftercoolers to remove the condensed moisture.

**3. Pressure vessel:** Pressure vessel plays very important role in compressed air system:

- Damping pulsations caused by reciprocating compressors
- Providing a location for free water and lubricant to settle from the compressed air stream
- Supplying peak demands from stored air without needing to run an extra compressor
- Reducing load/unload or start/stop cycle frequencies to help screw compressors run more efficiently and reduce motor starts
- Slowing system pressure changes to allow better compressor control and more stable system pressures

**4. Compressed air dryer :** Compressed air leaving the compressor aftercooler and moisture separator is normally warmer than the ambient air and fully saturated with moisture. As the air cools the moisture will condense in the compressed air lines. Excessive entrained moisture can result in undesired pipe corrosion and contamination at point of end use. For this reason some sort of air dryer is normally required.

Some end use applications require very dry air, such as compressed air distribution systems where pipes are exposed to winter conditions. Drying the air to dew points below ambient conditions is necessary to prevent ice buildup.

**Common types:**

- Refrigerant
- Dessicant
- Membrane



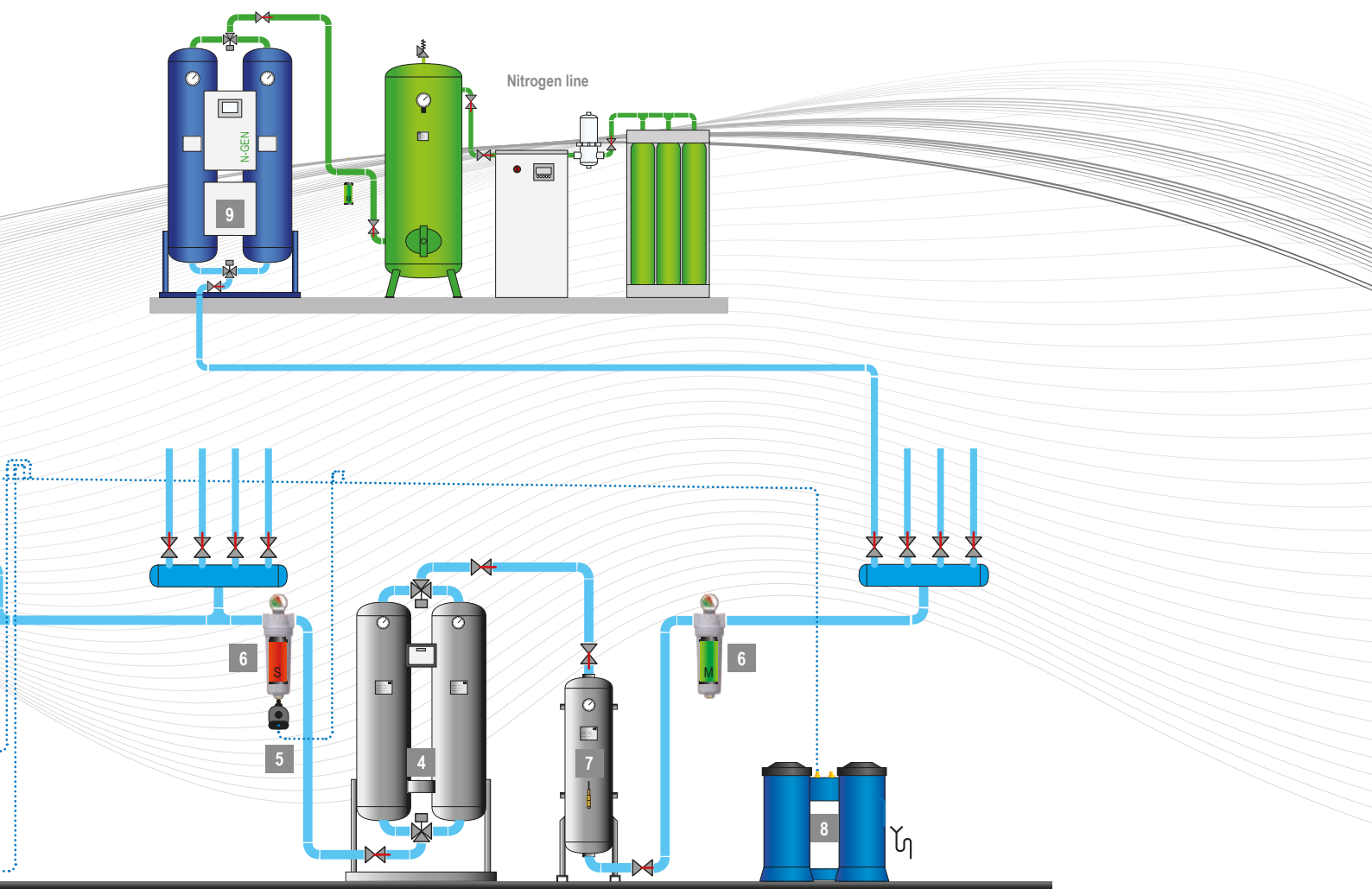

**5. Condensate drain:** Drains are needed at all separators, filters, dryers and receivers in order to remove the liquid condensate from the compressed air system.

Failed drains can allow slugs of moisture to flow downstream that can overload the air dryer and foul end use equipment.

**6. Filter:** Compressed air filters are used for high efficient removal of solid particles, water, oil aerosols, hydrocarbons, odour and vapours from compressed air systems.

To meet the required compressed air quality appropriate filter element must be installed into filter housing.

**7. Activated carbon tower:** Activated carbon tower eliminates hydrocarbon vapours and odours from compressed air. Towers are filled with activated carbon adsorbent that adsorbs contaminants onto the surface of its internal pores. Activated carbon towers are used at applications where content of oil vapours needs to be reduced to minimum.

Activated carbon towers can be incorporated in existing compressed air systems significantly minimising the risks of contamination.

They are able to absorb oil carry-over (both liquid and vapour) to provide the plant with technically oil-free compressed air.

**8. Oil/water separator:** Local environmental laws and regulations state that condensate drained from compressed air systems cannot be returned to the sewage system due to the content of compressor lubricating oil. Water/oil separators are one of the most effective and economical solution. Multi-stage separation process using oleophilic filters and activated carbon, ensures exceptional performance and trouble free operation.

**9. Nitrogen generator:** The nitrogen generators extract the available nitrogen in the ambient air from the other gases by applying the Pressure Swing Adsorption (PSA) technology. During the PSA process compressed, cleaned ambient air is led to a molecular sieve bed, which allows the nitrogen to pass through as a product gas, but adsorbs other gases.

#### End user advice

- Replace inappropriate end use applications with efficient models (vortex nozzles, atomizers)
- Install a flow controller to lower plant pressure and reduce artificial demand caused by higher than required pressures
- Turn off air consuming equipment, using electric solenoids or manual shutoff valves
- Avoid operation of air tools without a load, as this consumes more air than a tool under load
- Replace worn tools, as they often require higher pressure and consume excess compressed air than tools in good shape
- Lubricate air tools as recommended by the manufacturer. Keep air used by all end uses free of condensate in order to maximize tool life and effectiveness
- Where possible and practical, group end use air equipment that has similar air requirements of pressure and air quality

# CHF SERIES ALUMINUM COMPRESSED AIR FILTERS

### Applications

- General industrial applications
- Automotive
- Electronics
- Food and beverage
- Chemical
- Petrochemical
- Plastics
- Paint

### At a glance...



**Operating Pressure**  
17 bar



**Connections**  
3/8" - 3"



**Flow Rate**  
18 - 18247 cfm

The reliability of compressed air filtration is paramount to the ongoing fight against problems caused through contamination entering the air system. Contamination in the form of dirt, oil and water can lead to:

- Pipescale and corrosion within pressure vessels
- Damage to production equipment, air motors, air tools, valves and cylinders
- Premature and unplanned desiccant replacement for adsorption dryers
- Spoiled product

The Champion filtration range offers various products and grades of filtration to provide peace of mind whatever the air quality requirement. It has been designed with focus on reliability and efficiency.

### Designed and Built for Exceptional Performance

The advanced compressed air filter range from Champion reduces contamination in your air stream to help protect your critical processes and valuable equipment. These filters are rigorously tested and engineered with superior components to provide years of reliable performance and consistently high-quality air.

### The standard for high-quality air

The Champion filter range provides clean, high-quality air as defined by ISO 8573.1:2010 and are certified by a third party under ISO 12500-1.



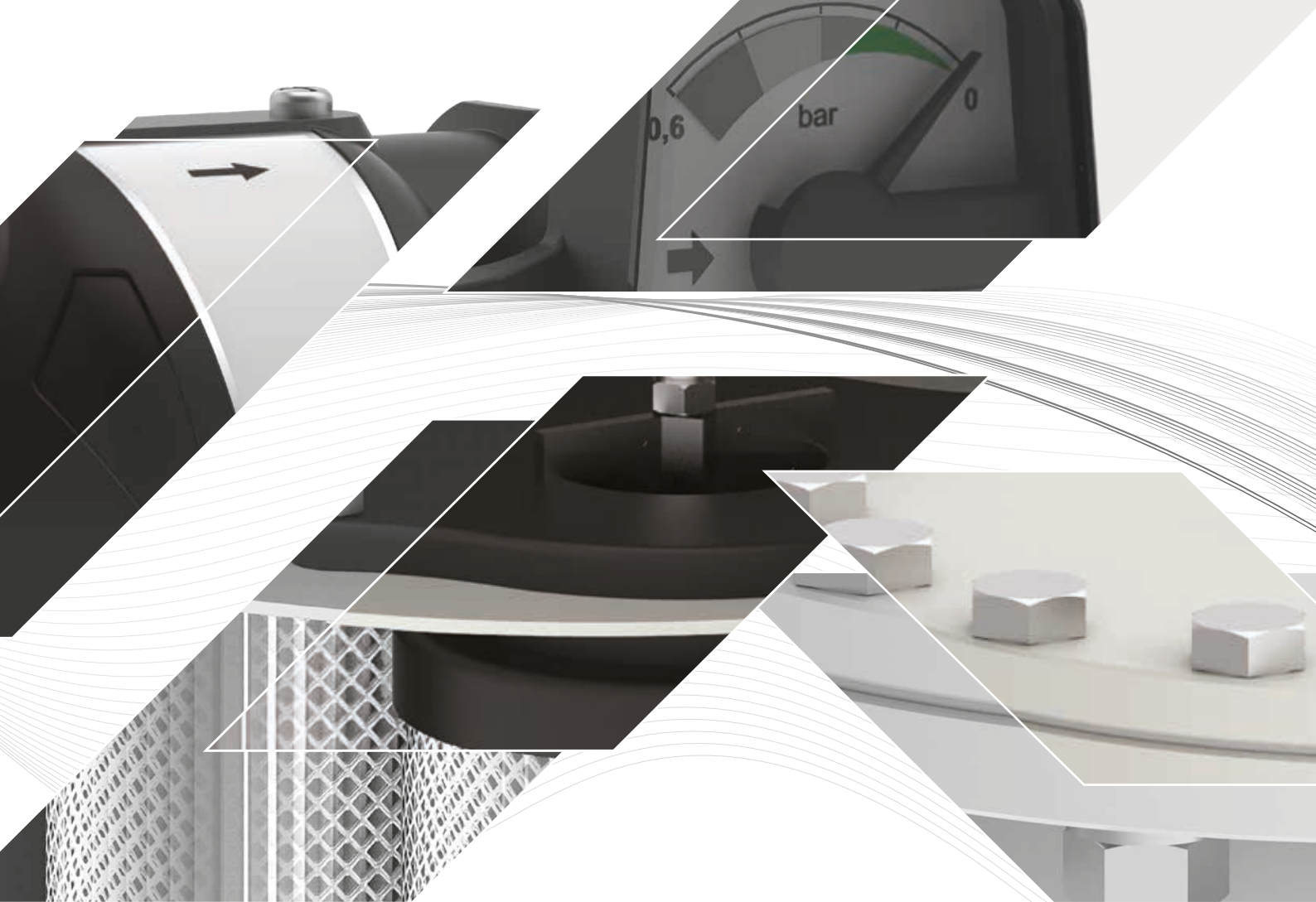

## Compressed Air Purification - The perfect choice!

### Water Separation – The CHF Range of water separators

The CHF-range of water separators provide bulk condensed water and liquid oil removal and are used to protect coalescing filters against bulk liquid contamination.

0.5 – 200 m<sup>3</sup>/min\*

18 – 7062 cfm\*



### Filtration – The CHF Range of compressed air filters

The CHF-range of filters efficiently removes water and oil aerosols, atmospheric dirt and solid particles, rust, pipescale and micro-organisms.

0.5 – 45 m<sup>3</sup>/min\*

18 – 1600 cfm\*



### Filtration – The CHF Range of flanged filters\*\*

For larger flowrate or higher pressure applications the flanged filters are available in the standard four filtration grades.

48 – 516 m<sup>3</sup>/min\*

1702 – 18247 cfm\*

\* Flow rate at 20° C, 7 bar

\*\* On request



Compressed air contamination will ultimately lead to:

- ▼ Inefficient production processes
- ▼ Spoiled, damaged or reworked products
- ▼ Reduced production efficiency
- ▼ Increased manufacturing costs



# COMPRESSED AIR FILTERS



## Superior Filtration Technology

- A** Patented dual indicator (optional accessory) shows differential pressure drop and economical operating efficiency
- B** Patented smooth bore flow insert directs air into the filter element, minimising turbulence and pressure losses
- C** All-aluminum, precision die cast body suitable for 80°C and 17 bar g maximum working pressure applications
- D** Proprietary coating applied to the inside and outside surfaces provides corrosion protection in harsh industrial environments
- E** Filter element with stainless steel mesh withstands high differential pressure while minimizing flow restriction through the element
- F** Ergonomic bowl design with no-touch filter element simplifies element replacement



- G** Time strip label indicates when it's time to change the element (CHF Grade only)
- H** Reliable discharge The M and S grade filters and water separators are equipped with internal float drain. The Particulate (R) and Activated Carbon (A) filters have manual drain
- I** Deep-pleated filter media reduces air flow velocity to maximise filtration efficiency and minimise pressure losses
- J** High-efficiency drainage layer improves liquid drainage properties and enhances chemical compatibility
- K** Simple visual alignment of the filter head and bowl ensures accurate assembly of components and helps to improve safety

## High efficiency bulk liquid removal

Water separators remove bulk liquids such as condensate, water and liquid oil from the air flow through directional and centrifugal separation. Installed before a coalescing filter the water separator can provide added protection against bulk liquid contamination enabling the filter to operate more efficiently.

The CHF Series water separator range from Champion can operate across various flow conditions and have been optimised to reduce differential pressure with very low maintenance.



### Technical Data - Compressed Air Condensate Separators - CHF Series

SEPARATOR MODEL	CHAMPION PART NUMBER [CCN]	CONNECTION SIZE	FLOW RATE		MAX. PRESSURE		DIMENSIONS		WEIGHT [kg]
			[m <sup>3</sup> /min]	[cfm]	[bar]	[psi]	W [mm]	H [mm]	
CHF005W	47700907001	3/8"	0.50	18	17	250	76	175	0.6
CHF007W	47700908001	1/2"	0.66	23	17	250	76	175	0.6
CHF018W	47700909001	3/4"	1.8	64	17	250	98	230	1.2
CHF040W	47700910001	1"	4.0	141	17	250	129	268	2.2
CHF085W	47700911001	1 1/2"	8.5	300	17	250	129	268	2.1
CHF170W	47700912001	2"	17.0	600	17	250	170	467	5.1
CHF380W	47700913001	3"	38.0	1342	17	250	205	548	20

### Technical Data - Compressed Air Filters CHF Series - Grade M

FILTER MODEL	PN	CONNECTION SIZE	FLOW RATE		MAX. PRESSURE		DIMENSIONS		WEIGHT [kg]
			[m <sup>3</sup> /min]	[cfm]	[bar]	[psi]	W [mm]	H [mm]	
CHF005M	47698906001	3/8"	0.5	18	17	250	76	225	0.55
CHF007M	47698907001	1/2"	0.7	24	17	250	76	225	0.55
CHF013M	47698908001	3/4"	1.3	44	17	250	98	280	1.07
CHF018M	47698909001	3/4"	1.8	65	17	250	98	280	1.09
CHF025M	47698910001	1"	2.5	88	17	250	129	319	2.06
CHF032M	47698911001	1"	3.2	112	17	250	129	319	2.06
CHF038M	47698912001	1"	3.8	135	17	250	129	319	2.06
CHF067M	47698913001	1 1/2"	6.7	235	17	250	129	409	2.36
CHF082M	47698914001	1 1/2"	8.2	288	17	250	129	409	2.36
CHF100M	47698915001	2"	10	353	17	250	170	518	5.2
CHF0133M	47698916001	2"	13.3	471	17	250	170	518	5.24
CHF0167M	47698917001	2"	16.7	589	17	250	170	518	5.26
CHF0200M	47698918001	3"	20	706	17	250	205	600	9.31
CHF0260M	47698919001	3"	26	918	17	250	205	700	10.69
CHF0305M	47698920001	3"	30.5	1077	17	250	205	700	10.69
CHF0383M	47698921001	3"	38.3	1354	17	250	205	930	13.7
CHF0450M	47698922001	3"	45	1589	17	250	205	930	13.7



# COMPRESSED AIR FILTERS



## Technical Data - Compressed Air Filters CHF Series - Grade S

FILTER MODEL	PN	CONNECTION SIZE	FLOW RATE		MAX. PRESSURE		DIMENSIONS		WEIGHT [kg]
			[m³/min]	[cfm]	[bar]	[psi]	W [mm]	H [mm]	
CHF005S	47698923001	3/8"	0.5	18	17	250	76	225	0.55
CHF007S	47698924001	1/2"	0.7	24	17	250	76	225	0.55
CHF013S	47698925001	3/4"	1.3	44	17	250	98	280	1.07
CHF018S	47698926001	3/4"	1.8	65	17	250	98	280	1.09
CHF025S	47698927001	1"	2.5	88	17	250	129	319	2.06
CHF032S	47698928001	1"	3.2	112	17	250	129	319	2.06
CHF038S	47698929001	1"	3.8	135	17	250	129	319	2.06
CHF067S	47698930001	1 1/2"	6.7	235	17	250	129	409	2.36
CHF082S	47698931001	1 1/2"	8.2	288	17	250	129	409	2.36
CHF100S	47698932001	2"	10	353	17	250	170	518	5.2
CHF0133S	47698933001	2"	13.3	471	17	250	170	518	5.24
CHF0167S	47698934001	2"	16.7	589	17	250	170	518	5.26
CHF0200S	47698935001	3"	20	706	17	250	205	600	9.31
CHF0260S	47698936001	3"	26	918	17	250	205	700	10.69
CHF0305S	47698937001	3"	30.5	1077	17	250	205	700	10.69
CHF0383S	47698938001	3"	38.3	1354	17	250	205	930	13.7
CHF0450S	47698939001	3"	45	1589	17	250	205	930	13.7

## Technical Data - Compressed Air Filters CHF Series - Grade A

FILTER MODEL	PN	CONNECTION SIZE	FLOW RATE		MAX. PRESSURE		DIMENSIONS		WEIGHT [kg]
			[m³/min]	[cfm]	[bar]	[psi]	W [mm]	H [mm]	
CHF005A	47698957001	3/8"	0.5	18	17	250	76	225	0.55
CHF007A	47698958001	1/2"	0.7	24	17	250	76	225	0.55
CHF013A	47698959001	3/4"	1.3	44	17	250	98	280	1.07
CHF018A	47698960001	3/4"	1.8	65	17	250	98	280	1.09
CHF025A	47698961001	1"	2.5	88	17	250	129	319	2.06
CHF032A	47698962001	1"	3.2	112	17	250	129	319	2.06
CHF038A	47698963001	1"	3.8	135	17	250	129	319	2.06
CHF067A	47698964001	1 1/2"	6.7	235	17	250	129	409	2.36
CHF082A	47698965001	1 1/2"	8.2	288	17	250	129	409	2.36
CHF100A	47698966001	2"	10	353	17	250	170	518	5.2
CHF0133A	47698967001	2"	13.3	471	17	250	170	518	5.24
CHF0167A	47698968001	2"	16.7	589	17	250	170	518	5.26
CHF0200A	47698969001	3"	20	706	17	250	205	600	9.31
CHF0260A	47698970001	3"	26	918	17	250	205	700	10.69
CHF0305A	47698971001	3"	30.5	1077	17	250	205	700	10.69
CHF0383A	47698972001	3"	38.3	1354	17	250	205	930	13.7
CHF0450A	47698973001	3"	45	1589	17	250	205	930	13.7



## Technical Data - Compressed Air Filters CHF Series - Grade R

FILTER MODEL	PN	CONNECTION SIZE	FLOW RATE		MAX. PRESSURE		DIMENSIONS		WEIGHT [kg]
			[m³/min]	[cfm]	[bar]	[psi]	W [mm]	H [mm]	
CHF005R	47698940001	3/8"	0.5	18	17	250	76	225	0.55
CHF007R	47698941001	1/2"	0.7	24	17	250	76	225	0.55
CHF013R	47698942001	3/4"	1.3	44	17	250	98	280	1.07
CHF018R	47698943001	3/4"	1.8	65	17	250	98	280	1.09
CHF025R	47698944001	1"	2.5	88	17	250	129	319	2.06
CHF032R	47698945001	1"	3.2	112	17	250	129	319	2.06
CHF038R	47698946001	1"	3.8	135	17	250	129	319	2.06
CHF067R	47698947001	1 1/2"	6.7	235	17	250	129	409	2.36
CHF082R	47698948001	1 1/2"	8.2	288	17	250	129	409	2.36
CHF100R	47698949001	2"	10	353	17	250	170	518	5.2
CHF0133R	47698950001	2"	13.3	471	17	250	170	518	5.24
CHF0167R	47698951001	2"	16.7	589	17	250	170	518	5.26
CHF0200R	47698952001	3"	20	706	17	250	205	600	9.31
CHF0260R	47698953001	3"	26	918	17	250	205	700	10.69
CHF0305R	47698954001	3"	30.5	1077	17	250	205	700	10.69
CHF0383R	47698955001	3"	38.3	1354	17	250	205	930	13.7
CHF0450R	47698956001	3"	45	1589	17	250	205	930	13.7

### Grade M - General Purpose Protection

Particle removal down to 0.1 micron including coalesced liquid, water and oil, providing a maximum remaining oil aerosol content of 0.03 mg/m³ @ 21°C

### Grade S - High Efficiency Oil Removal Filtration

Particle removal down to 0.01 micron including water and oil aerosols, providing a maximum remaining oil aerosol content of 0.01 mg/m³ @ 21°C

(Precede with Grade M filter)

### Operating Limitations:

Max Operating Pressure 17.2 bar g  
 Max Recommended Operating Temp 80°C (Grade M, S, R)

### Grade A - Activated Carbon Filtration

Oil vapor and hydrocarbon odor removal, providing a maximum remaining oil content of <0.003 mg/m³ (<0.003 ppm) @ 21°C (Precede with Grade S filter)

### Grade R - General Purpose Dust Filtration

Dust particle removal down to 1 micron

Max Recommended Operating Temp 50°C (Grade A)  
 Min Recommended Operating Temp 1°C

LINE PRESSURE	bar g	1	2	3	5	7	9	11	13	15	17
CORRECTION FACTOR		0.38	0.53	0.65	0.85	1.00	1.13	1.25	1.36	1.46	1.56

To use correction factors, multiply the filter's capacity by the correction factor to get the new filter flow capacity at the non-standard operating pressure. For example, a 190 m³/h filter operating at 11 bar has a correction factor of 1.25. 1.25 x 190 = 237.5 m³/h capacity at 11 bar.

# FILTER ELEMENTS



## Technical Data - Compressed Air Filter Elements CHF Series - Grade M

FILTER MODEL	FILTER ELEMENT
CHF005M	47699428001
CHF007M	47699432001
CHF013M	47699436001
CHF018M	47699440001
CHF025M	47699444001
CHF032M	47699448001
CHF038M	47699452001
CHF067M	47699456001
CHF082M	47699460001
CHF100M	47699464001
CHF0133M	47699468001
CHF0167M	47699472001
CHF0200M	47699476001
CHF0260M	47700081001
CHF0305M	47700085001
CHF0383M	47700089001
CHF0450M	47700093001

## Technical Data - Compressed Air Filter Elements CHF Series - Grade A

FILTER MODEL	FILTER ELEMENT
CHF005A	47699431001
CHF007A	47699435001
CHF013A	47699439001
CHF018A	47699443001
CHF025A	47699447001
CHF032A	47699451001
CHF038A	47699455001
CHF067A	47699459001
CHF082A	47699463001
CHF100A	47699467001
CHF0133A	47699471001
CHF0167A	47699475001
CHF0200A	47700080001
CHF0260A	47700084001
CHF0305A	47700088001
CHF0383A	47700092001
CHF0450A	47700096001

## Technical Data - Compressed Air Filter Elements CHF Series - Grade S

FILTER MODEL	FILTER ELEMENT
CHF005S	47699429001
CHF007S	47699433001
CHF013S	47699437001
CHF018S	47699441001
CHF025S	47699445001
CHF032S	47699449001
CHF038S	47699453001
CHF067S	47699457001
CHF082S	47699461001
CHF100S	47699465001
CHF0133S	47699469001
CHF0167S	47699473001
CHF0200S	47700078001
CHF0260S	47700082001
CHF0305S	47700086001
CHF0383S	47700090001
CHF0450S	47700094001

## Technical Data - Compressed Air Filter Elements CHF Series - Grade R

FILTER MODEL	FILTER ELEMENT
CHF005R	47699430001
CHF007R	47699434001
CHF013R	47699438001
CHF018R	47699442001
CHF025R	47699446001
CHF032R	47699450001
CHF038R	47699454001
CHF067R	47699458001
CHF082R	47699462001
CHF100R	47699466001
CHF0133R	47699470001
CHF0167R	47699474001
CHF0200R	47700079001
CHF0260R	47700083001
CHF0305R	47700087001
CHF0383R	47700091001
CHF0450R	47700095001





# CHR SERIES REFRIGERATION AIR DRYERS

### Applications

- Compressed air systems

### At a glance...



**Operating Pressure**  
16/14 bar g



**Inlet air temperature**  
35 °C (55° max)



**Ambient temperature**  
25 °C (45° max)

The advanced design and innovative technology offered by CHR Series refrigeration dryers provides an optimised performance alongside a more efficient mode of management.

The electronic controller, complete with user-friendly interface, has been simplified to focus on the essential functions of operation and regulation, including the unique fan control (CHR6 – CHR167).

Simplicity in design, unrivalled reliability, and extraordinary value for money are the core strengths of this new family of units.

### Standard voltage

- CHR6 – CHR36: 230V/1ph/50-60Hz
- CHR47 – CHR167: 230V/1ph/50Hz
- CHR217 – CHR350: 400V/3ph/50Hz

### Main design features

#### Variable speed fan

The only one in the market to offer a complete control of the dew point through the variable speed fan controlled by the microprocessor. Thanks to this solution we've eliminated the hot gas bypass valve and the fan pressure switch, critical components for the defects of this type of machines.

#### Multi-function control panel

It offers a wide range of parameters and alarms such as: high temperature, low temperature (antifreeze), probe failure, alarm history, etc.



### Available options

- Non-standard voltages  
CHR47 – CHR125 are available with 230V/1ph/60Hz  
CHR217 is available with 460V/3ph/60Hz
- All models are available with NPT connections

#### New heat exchangers

Completely designed in our laboratories to guarantee the desired level of performances with the lowest pressure drop.

#### Energy saving and antifreeze mode

The compressor stops in case of low load and ambient temperature below 15 °C.

#### Compact and simple design

Sheet metal panels and internal components designed in order to reduce costs during assembly, maintaining the high quality guaranteed by Champion.



**For higher capacities up to 45 m<sup>3</sup>/min (2,700 m<sup>3</sup>/h) please contact the Champion Sales Team**

DRYER	PN	AIR FLOW		ABSORBED POWER [kW]	POWER SUPPLY [V/PH/HZ]	MAX PRESSURE [bar g]	AIR CONNECTIONS [BSP]	REFRIGERANT	DIMENSIONS		
		[m <sup>3</sup> /h]	[m <sup>3</sup> /min]						W [mm]	D [mm]	H [mm]
CHR6	47703069001	36	0.60	0.12	230/1/50-60	16	3/8"	R513A	305	360	408
CHR9	47703070001	54	0.90	0.17	230/1/50-60	16	1/2"	R513A	325	430	445
CHR12	47703071001	72	1.20	0.17	230/1/50-60	16	1/2"	R513A	325	430	445
CHR18	47703072001	108	1.80	0.29	230/1/50-60	16	1/2"	R513A	325	430	445
CHR24	47703073001	144	2.40	0.41	230/1/50-60	16	3/4"	R513A	395	486	565
CHR30	47703074001	180	3.00	0.47	230/1/50-60	16	3/4"	R513A	395	486	565
CHR36	47703075001	216	3.60	0.61	230/1/50-60	16	3/4"	R513A	395	486	565
CHR47	47703076001	280	4.67	0.6	230/1/50	16	1"	R407C	485	595	614
CHR57	47703077001	340	5.67	0.6	230/1/50	16	1"	R407C	485	595	614
CHR83	47703078001	500	8.33	0.9	230/1/50	16	1-1/2"	R407C	500	660	970
CHR102	47703079001	610	10.17	0.9	230/1/50	16	1-1/2"	R407C	500	660	970
CHR125	47703080001	750	12.50	1.23	230/1/50	14	2"	R407C	520	800	1195
CHR167	47703081001	1000	16.67	1.43	230/1/50	14	2-1/2"	R407C	520	835	1195
CHR217	47703082001	1300	21.67	2.14	400/3/50	14	2-1/2"	R407C	520	835	1230
CHR333	47703083001	2000	33.33	2.78	400/3/50	14	3"	R407C	806	1012	1539
CHR417	47703084001	2500	41.67	3.54	400/3/50	14	3"	R407C	806	1012	1539
CHR500	47716993001	3540	59.00	6.29	400/3/50	13	DN125	R407C	1500	1500	1555
CHR700	47716994001	4956	82.60	7.29	400/3/50	13	DN125	R407C	1500	1500	1555
CHR800	47716995001	5664	94.40	9.52	400/3/50	13	DN150	R407C	1500	1500	1555
CHR900	47716996001	6372	106.20	9.52	400/3/50	13	DN150	R407C	1500	1500	1555

Timer drain as standard, electronic no loss drain option on request on Models CHR6 - CHR217. Integrated zero loss drain as standard on Models CHR333 and CHR417.

#### CORRECTION FACTOR FOR WORKING PRESSURE

OPERATING PRESSURE [bar]	3	4	5	6	7	8	9	10	11	12	13	14	15	16
CORRECTION FACTOR FC1	0.70	0.78	0.85	0.93	1.00	1.06	1.11	1.15	1.18	1.20	1.22	1.24	1.25	1.26

#### CORRECTION FACTOR FOR INLET AIR TEMPERATURE CHANGES

TEMPERATURE [°C]	30	35	40	45	50	55
CORRECTION FACTOR FC2	1.20	1.00	0.85	0.71	0.58	0.49

#### CORRECTION FACTOR FOR AMBIENT TEMPERATURE CHANGES

TEMPERATURE [°C]	25	30	35	40	42	45
CORRECTION FACTOR FC3	1.00	0.96	0.92	0.88	0.85	0.80

Calculation for correct Dryer Air flow = Nominal Dryer Air Flow x FC1 x FC2 x FC3



## MODULAR DESICCANT DRYERS

# MODULAR DESICCANT DRYERS

### Applications

- Automotive
- Food and beverage
- Pharmaceutical
- Chemical
- Oil & Gas

### At a glance...



**Operating Pressure**  
14 bar



**Flow Rate**  
0.08 - 5.00 m<sup>3</sup>/min



**Pressure Dew Points**  
-40°C (-25°C / -70°C)

### A-Series modular compressed air dryers - a dedicated solution for every application

By combining the proven benefits of desiccant drying with modern design, Champion provides an extremely compact and reliable system to dry and clean compressed air efficiently.

At the heart of any compressed air treatment solution is the dryer, its purpose, to remove water vapour, stop condensation, corrosion and in the case of adsorption dryers, inhibit the growth of micro-organisms.

The Champion A-Series of heatless regenerative desiccant dryers have proven to be the ideal solution for many thousands of compressed air users worldwide in a wide variety of industries.

### Advantages at a glance:

- Robust and reliable industry-proven design
- Suitable for all industries and applications - some desiccant dryer regeneration methods prevent their use in certain industries/applications
- Lower capital investment and reduced complexity compared to other dryer regeneration methods
- Lower maintenance costs in comparison to other dryer regeneration methods
- No heat, heaters, or heat-related issues

### High air quality, low cost of ownership

#### Features are your benefits

#### High Air Quality:

Delivers ISO Class 2 or Class 1 pressure dew point air for critical applications; high efficiency pre and post-filters provide constant high air quality, protecting downstream air from contamination.

#### Superior Reliability:

Proven electronic control performance indicators, extruded aluminium with anodisation and epoxy painting, and NEMA 3/IP54 Protection (also suitable for outdoor installation) make desiccant dryers durable and high-strength.



#### Total Cost of Investment:

Reduced cost of ownership with point of use design to treat only the required air, conservative pressure drop 0.2 Barg, and purge reduction on compressed air demand (on/off-load).

#### Ease of Use:

User-friendly electronic interface with alarm indicators available for models 40 and above.

#### Serviceability:

Modular dryers feature an optimised design for simplified maintenance and preventative maintenance alerts (models 40 and above).

#### Compact & Flexible Solution:

Space-saving design for optimised installation with air inlet and outlet in the back of unit and connection piping can come from right or left. Model up to 0.42 m<sup>3</sup>/min can be wall-mounted or installed horizontally

#### Performance Improvement:

Extended rated pressure range from 4 to 14 Barg and increased airflow range coverage up to 300 m<sup>3</sup>/h. Guaranteed class 2 (-40°C) and optionally class 1 (-70°C) pressure dew point.

#### Longer Cycle Life:

Modular dryers have a longer cycle time, 10 minutes, than most competitors (4 to 8 minutes maximum).

## CHA1M -40°C to CHA50M -40°C Series

TYPE	PART NO	CAPACITY			MAX PRESSURE		PRESSURE DEW POINT	AIR IN/OUT CONNEC-TION	POWER SUPPLY	DIMENSIONS [MM]			WEIGHT	DESICCANT PER TOWER
		[m³/min]	[m³/h]	[SCFM]	[bar g]	[psig]				[°C]	[BSP (in)]	[V/Ph/Hz]		
CHA1 -40°C	47700856001	0.08	5	3	14	203	-40	3/8"	230/1/50-60	238	212	423	11	0.7
CHA3 -40°C	47700857001	0.25	15	9	14	203	-40	3/8"	230/1/50-60	238	212	823	18	2.2
CHA4 -40°C	47700858001	0.42	25	15	14	203	-40	3/8"	230/1/50-60	238	212	1073	27	3.0
CHA7 -40°C	47700859001	0.67	40	24	14	203	-40	3/4"	230/1/50-60	475	405	968	44	6.4
CHA9 -40°C	47700860001	0.92	55	32	14	203	-40	3/4"	230/1/50-60	475	405	1118	50	8.4
CHA12 -40°C	47700861001	1.17	70	41	14	203	-40	3/4"	230/1/50-60	475	405	1318	60	10.9
CHA17 -40°C	47700862001	1.67	100	59	14	203	-40	1"	230/1/50-60	475	405	1673	73	15.4
CHA25 -40°C	47700863001	2.50	150	88	14	203	-40	1"	230/1/50-60	475	405	1873	90	18.0
CHA33 -40°C	47700864001	3.33	200	118	14	203	-40	1 1/2"	230/1/50-60	536	495	1705	177	30.8
CHA42 -40°C	47700865001	4.17	250	147	14	203	-40	1 1/2"	230/1/50-60	536	495	1905	180	35.9
CHA50 -40°C	47700866001	5.00	300	177	14	203	-40	1 1/2"	230/1/50-60	536	495	1905	188	35.9

## CHA7 -40°C DS to CHA50M -40°C ES Series

TYPE	PART NO	CAPACITY			MAX PRESSURE		PRESSURE DEW POINT	AIR IN/OUT CONNEC-TION	POWER SUPPLY	DIMENSIONS [MM]			WEIGHT	DESICCANT PER TOWER
		[m³/min]	[m³/h]	[SCFM]	[bar g]	[psig]				[°C]	[BSP (in)]	[V/Ph/Hz]		
CHA7 -40°C ES	47700867001	0.67	40	24	14	203	-40	3/4"	230/1/50-60	475	405	968	44	6.4
CHA9 -40°C ES	47700868001	0.92	55	32	14	203	-40	3/4"	230/1/50-60	475	405	1118	50	8.4
CHA12 -40°C ES	47700869001	1.17	70	41	14	203	-40	3/4"	230/1/50-60	475	405	1318	60	10.9
CHA17 -40°C ES	47700870001	1.67	100	59	14	203	-40	1"	230/1/50-60	475	405	1673	73	15.4
CHA25 -40°C ES	47700871001	2.50	150	88	14	203	-40	1"	230/1/50-60	475	405	1873	90	18.0
CHA33 -40°C ES	47700872001	3.33	200	118	14	203	-40	1 1/2"	230/1/50-60	536	495	1705	177	30.8
CHA42 -40°C ES	47700873001	4.17	250	147	14	203	-40	1 1/2"	230/1/50-60	536	495	1905	180	35.9
CHA50 -40°C ES	47700874001	5.00	300	177	14	203	-40	1 1/2"	230/1/50-60	536	495	1905	188	35.9

## CHA7 -70°C to CHA50M -70°C Series

TYPE	PART NO	CAPACITY			MAX PRESSURE		PRESSURE DEW POINT	AIR IN/OUT CONNEC-TION	POWER SUPPLY	DIMENSIONS [MM]			WEIGHT	DESICCANT PER TOWER
		[m³/min]	[m³/h]	[SCFM]	[bar g]	[psig]				[°C]	[BSP (in)]	[V/Ph/Hz]		
CHA7 -70°C	47700875001	0.53	32	19	14	203	-70	3/4"	230/1/50-60	475	405	968	44	6.4
CHA9 -70°C	47700876001	0.73	44	26	14	203	-70	3/4"	230/1/50-60	475	405	1118	50	8.4
CHA12 -70°C	47700877001	0.93	56	33	14	203	-70	3/4"	230/1/50-60	475	405	1318	60	10.9
CHA17 -70°C	47700878001	1.33	80	47	14	203	-70	1"	230/1/50-60	475	405	1673	73	15.4
CHA25 -70°C	47700879001	2.00	120	71	14	203	-70	1"	230/1/50-60	475	405	1873	90	18.0
CHA33 -70°C	47700880001	2.67	160	94	14	203	-70	1 1/2"	230/1/50-60	536	495	1705	177	30.8
CHA42 -70°C	47700881001	3.33	200	118	14	203	-70	1 1/2"	230/1/50-60	536	495	1905	180	35.9
CHA50 -70°C	47700882001	4.00	240	142	14	203	-70	1 1/2"	230/1/50-60	536	495	1905	188	35.9

## CORRECTION FACTORS

		INLET AIR PRESSURE											
		bar g	4	5	6	7	8	9	10	11	12	13	14
INLET AIR TEMPERATURE	35°C	0.63	0.75	0.88	1.00	1.14	1.25	1.37	1.49	1.64	1.75	1.89	
	40°C	0.55	0.66	0.77	0.88	1.00	1.00	1.20	1.32	1.43	1.54	1.64	
	45°C	0.45	0.54	0.63	0.72	0.81	0.90	1.00	1.08	1.18	1.27	1.35	
	50°C	0.32	0.39	0.45	0.52	0.58	0.65	0.71	0.78	0.85	0.91	0.97	

		INLET AIR PRESSURE											
		psi g	58	73	87	102	116	131	145	160	174	189	203
INLET AIR TEMPERATURE	95°F	0.63	0.75	0.88	1.00	1.14	1.25	1.37	1.49	1.64	1.75	1.89	
	104°F	0.55	0.66	0.77	0.88	1.00	1.00	1.20	1.32	1.43	1.54	1.64	
	113°F	0.45	0.54	0.63	0.72	0.81	0.90	1.00	1.08	1.18	1.27	1.35	
	122°F	0.32	0.39	0.45	0.52	0.58	0.65	0.71	0.78	0.85	0.91	0.97	

Prefilters and Postfilter are supplied as standard on Modular Dryers.

### Prefilter

Particle removal down to 0.01 micron

- Including water and oil aerosols
- Maximum remaining oil aerosol content of 0.01 mg/m³ @ 21°C

### Postfilter

Particle removal down to 0.1 micron

- Including coalesced liquid, water and oil
- Maximum remaining oil aerosol content of 0.03 mg/m³ @ 21°C

# TWIN TOWER HEATLESS DESICCANT DRYERS

## At a glance...



**Capacity**  
400 - 8500 m<sup>3</sup>/hr



**Weight**  
285 - 4400 kg



**Connection Size**  
1½ - 3"

## Applications

- Air bearings
- Instrument Air
- Sand blasting
- Air gauging
- Spray painting
- Chemical Process - Oxidation, Ammonia Production
- Conveying, powder products
- Fluidics, sensors
- Food & beverages, direct air contact
- Micro-electronics manufacture
- Clean room processing air - blanketing
- Food & beverage - packaging, forming
- Photographic film processing



## Premium in-house air treatment manufacturing

A modern production system and process demands increasing levels of air quality, and compressed air operators need to ensure that the downstream equipment also delivers on it 100%.

The new downstream portfolio manufactured by Champion utilising the latest technology provides an energy efficient solution at the lowest life cycle costs. The same quality, performance, and efficiency standards delivered by the compressors can now be enjoyed from the air treatment range.

Investment in our manufacturing site, in addition to the support teams, ensures that compressed air operators don't need to worry about the quality of their compressed air – quality that is key to ensuring maximum production efficiency and investment protection.

TYPE	PART NO	CONNECTION SIZE	CAPACITY		WEIGHT	DIMENSIONS		
			[inch]	[m <sup>3</sup> /hr]		[m <sup>3</sup> /hr]	[kg]	LENGTH
CHT67F	47726991001	1 ½"	400	340	285	2160	825	530
CHT83F	47726992001	1 ½"	500	425	400	2380	796	550
CHT125F	47726993001	2"	750	637.5	520	2117	970	620
CHT150F	47726994001	2"	900	765	700	2305	970	620
CHT67FS	47727056001	1 ½"	400	340	285	2160	825	530
CHT83FS	47727057001	1 ½"	500	425	400	2380	796	550
CHT125FS	47727058001	2"	750	637.5	520	2117	970	620
CHT150FS	47727059001	2"	900	765	700	2305	970	620
CHT67F-70	47727069001	1 ½"	400	340	285	2160	825	530
CHT83F-70	47727070001	1 ½"	500	425	400	2380	796	550
CHT125F-70	47727071001	2"	750	637.5	520	2117	970	620
CHT150F-70	47727072001	2"	900	765	700	2305	970	620

CHT67F to CHT150F is standard at -40°C PDP, CHT67FS to CHT150FS is standard at -40°C PDP with Energy Management System, CHT67F-70 to CHT150F-70 is at -70°C PDP



# CHM-DRY SERIES

## MEMBRANE DRYERS

### At a glance...



**Operating Pressure**  
12 bar



**Flow Rate**  
0.05 - 3 m<sup>3</sup>/min



**Pipe Size**  
¼ - 1"



**Operating Temp. Range**  
1.5 - 60°C



### Applications

- Automotive painting
- Industrial "Point-Of-Use" drying
- Low dew point instrument air
- Pneumatics
- Medical air
- Analytical Equipment
- Pressurising electrical cabinets

CHM-DRY membrane air dryers have been developed for high efficient removal of water vapours from compressed air.

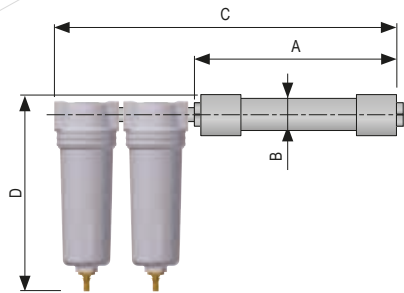

TYPE	PART NO	PIPE SIZE [inch]	OPERATING PRESSURE [bar]	FLOW RATE *		DIMENSIONS			
				[m <sup>3</sup> /min]	[cfm]	A [mm]	B [mm]	C [mm]	D [mm]
CHM-DRY 3	CC1189577	¼	12	0.05	1.8	224	43.7	325	175
CHM-DRY 6	CC1189578	¼	12	0.1	3.5	325	43.7	453	175
CHM-DRY 9	CC1189579	¼	12	0.15	5.3	427	43.7	555	175
CHM-DRY 12	CC1189580	¼	12	0.2	7.1	503	43.7	611	175
CHM-DRY 18	CC1189581	½	12	0.3	10.6	312	61	476	208
CHM-DRY 24	CC1189582	½	12	0.4	14.1	376	61	540	208
CHM-DRY 32	CC1189583	½	12	0.6	21.2	465	61	661	208
CHM-DRY 44	CC1189584	½	12	0.8	28.3	592	61	788	208
CHM-DRY 63	CC1189585	½	12	1.05	37.1	411	89	607	208
CHM-DRY 90	CC1189586	½	12	1.5	53	551	89	755	284
CHM-DRY 123	CC1189587	½	12	2.05	72.4	551	89	577	284
CHM-DRY 180	CC1189588	½	12	3	106.6	607	114	1,805	290

\* At 7 bar, inlet dew point 35 °C, outlet dew point 15 °C.

Prices includes complete kit.

OPERATING PRESSURE - CORRECTION FACTORS - C									
OPERATING PRESSURE [bar]	4	5	6	7	8	9	10	11	12
OPERATING PRESSURE [psi]	58	72	87	100	115	130	145	160	174
CORRECTION FACTOR	0.41	0.56	0.76	1	1.22	1.48	1.76	1.86	2.22

## AIRCOOLED AFTERCOOLERS

# CHRA SERIES AIR COOLED AFTERCOOLERS

### At a glance...



**Operating Pressure**  
1 - 16 bar



**Flow Rate**  
1.1 - 75 m<sup>3</sup>/min



**Operating Temp. Range**  
25 - 120°C



**Pipe Size**  
1 - 2½"

Air cooled aftercoolers series CHRA have been designed to reduce compressed air temperature and water vapour dew point in compressed air system. A high efficiency axial fan forces ambient air over the heat exchangers copper tubes supported by aluminium fins, which provides the necessary cooling effect. The compressed air is cooled down to approximately 10°C above ambient temperature. CHRA aftercoolers ensures the maximum performance and protection of all equipment, such as refrigeration dryers, adsorption dryers and filters, positioned downstream of this unit.



TYPE	PART NO	FLOW RATE		AIR		FAN [W]	OPERATING PRESSURE [bar]	DIMENSIONS [mm]		WEIGHT [kg]
		[m <sup>3</sup> /min]	[cfm]	[IN]	[OUT]			LENGTH	HEIGHT	
RA10	ON REQUEST	1	60	1"	1"	20	1 - 16	600	955	19
RA20	ON REQUEST	2	120	1"	1"	20	1 - 16	600	955	20
RA30	ON REQUEST	3	180	1 1/2"	1 1/2"	115	1 - 16	820	1145	29
RA40	ON REQUEST	4	240	1 1/2"	1 1/2"	135	1 - 16	1030	1145	32
RA65	ON REQUEST	6.5	390	2"	1 1/2"	690	1 - 16	970	1365	51
RA80	ON REQUEST	8	480	2"	1 1/2"	690	1 - 16	965	1405	53
RA120	ON REQUEST	12	720	2"	2"	760	1 - 16	1000	1555	97
RA160	ON REQUEST	16	960	2 1/2"	2 1/2"	760	1 - 16	1205	1765	120
RA200	ON REQUEST	20	1200	3"	2 1/2"	660	1 - 16	1410	2120	240
RA250	ON REQUEST	25	1500	3"	3"	660	1 - 16	1410	2120	250
RA300	ON REQUEST	30	1800	DN100	DN100	660	1 - 16	2095	2060	280
RA400	ON REQUEST	40	2400	DN100	DN100	2 x 760	1 - 16	2415	2050	300
RA500	ON REQUEST	50	3000	DN125	DN125	2 x 1300	1 - 12	3245	2000	310
RA650	ON REQUEST	65	3900	DN125	DN125	2 x 1300	1 - 12	3245	2000	390
RA700	ON REQUEST	75	4500	DN150	DN150	2 x 1300	1 - 12	3325	2150	390

# CHA SERIES

## WATER COOLED AFTERCOOLERS

### At a glance...



**Operating Pressure**  
1 - 12 bar



**Flow Rate**  
2.2 - 759.5 m<sup>3</sup>/min



**Operating Temp. Range**  
1.5 - 200°C

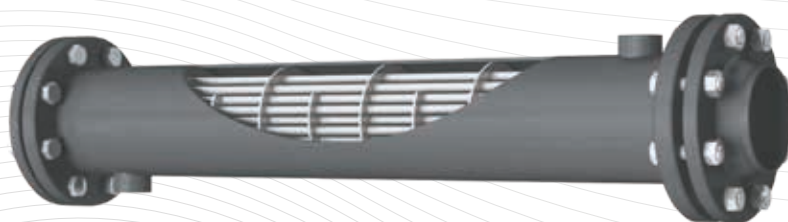

### Applications

- Automotive
- Electronics
- Food & Beverage
- Chemical
- Petrochemical
- Plastics
- Paint
- General industrial application

Water-cooled aftercoolers series CHA have been designed, to reduce compressed air temperature thus water vapour content in compressed air system. Hot compressed air/gas passes through the tubes. Cooling water passes around the tubes in counter flow. CHA aftercooler ensures the maximum performance and protection of all equipment, such as refrigeration dryers, adsorption dryers and filters, positioned downstream of this unit.

TYPE	PART NO	AIR		OPERATING PRESSURE [bar]	FLOW RATE		DIMENSIONS	
		[IN]	[OUT]		[m <sup>3</sup> /min]	[cfm]	A [mm]	B [mm]
A30	ON REQUEST	1 1/2"	1 1/2"	1 - 12	3	106	850	385
A60	ON REQUEST	2 1/2"	1 1/2"	1 - 12	6	212	1060	385
A80	ON REQUEST	2 1/2"	1 1/2"	1 - 12	8	282	1300	385
A140	ON REQUEST	DN100	DN100	1 - 12	14	494	1300	702
A250	ON REQUEST	DN100	DN100	1 - 12	25	882	1300	702
A400	ON REQUEST	DN150	DN125	1 - 12	40	1412	1300	702
A500	ON REQUEST	DN175	DN125	1 - 12	50	1765	1300	770
A800	ON REQUEST	DN250	DN150	1 - 12	80	2824	1300	845
A1100	ON REQUEST	DN250	DN150	1 - 12	110	3882	1300	845
A1500	ON REQUEST	DN300	DN200	1 - 12	150	5294	1300	925
A1800	ON REQUEST	DN350	DN200	1 - 12	180	6353	1300	925
A2100	ON REQUEST	DN400	DN200	1 - 12	210	7412	1500	925



# ACTIVATED CARBON TOWER CH-FT SERIES

### At a glance...



**Operating Pressure**  
13 - 15 barg



**Flow Rate**  
0.5 - 95 m<sup>3</sup>/min



**Operating Temp. Range**  
2 - 50 °C



**Pipe Size**  
3/8" to 3"  
Flange DN100 and DN150

### Applications

- Automotive
- Electronics
- Food and beverage
- Chemical
- Petrochemical
- Plastics
- Paint
- General industrial application

The activated carbon tower eliminates oil vapour and hydrocarbon odours from your operations. Available in two configurations: – aluminum extrusion and fabricated tank are easy to maintain. In critical applications like food and pharmaceutical production where oil content ISO8573-1 Class 1 air or better is crucial, this carbon adsorption technology helps achieve the highest quality “technically oil-free air”.

Extruded aluminum units are up to model CHFT58L and are lightweight (CHFT5L can be wall-mounted). As per the tank configuration, they can be used in compressed air systems or at the point of use. Rightsizing units with corrective factors ensures consistent outlet air quality over 12 months of continuous operations.

This activated carbon tower is a cost-effective, adaptable solution to your oil-free compressed air requirements from the experts at Champion. Deliver Class 0 Air when installed with upstream and downstream filters to intercept activated carbon dust.

- Virtually Oil Free Air: ISO8573-1 Class 0: 0.003 mg/m<sup>3</sup> oil content when used with inline filters
- Can be used with Oil Free and Contact Cooled Compressors
- Easy to replace lose high quality Activated Carbon Molecular Sieve
- Long service interval - media replacement every 12 months





## CH-FT ACTIVATED CARBON TOWER

MODEL	CODE	GAS	BAR	M <sup>3</sup> /MIN	CFM	A	B	C	KG
CHFT5L	47745977001	1/2"	14	0.5	17.66	749	212	143	8
CHFT12L	47745978001	3/4"	14	1.25	44.14	890	267	255	20
CHFT18L	47745979001	1"	14	1.83	64.63	1090	267	255	24
CHFT25L	47745980001	1"	14	2.5	88.29	1440	267	255	32
CHFT30L	47745981001	1"	14	3	105.94	1640	267	255	35
CHFT58L	47745982001	1 1/2"	14	5.83	205.88	1660	447	255	70
CHFT100L	47745983001	2"	15	10	353.15	2113	391	N/A	115
CHFT166L	47745984001	2"	15	16.67	588.70	2148	436	N/A	245
CHFT260L	47745985001	3"	15	26	918.18	2463	483	N/A	222
CHFT383L	47745986001	3"	15	38.33	1353.61	2693	595	N/A	379
CHFT466L	47745987001	DN100	13	46.67	1648.14	2879	721	N/A	456
CHFT950L	47745988001	DN150	13	95	3354.90	3455	855	N/A	900

## CH-FT ACTIVATED CARBON TOWER SERVICE KITS

MODEL	CODE
Kit CHFT5L Champion	47752199001
Kit CHFT12L Champion	47752200001
Kit CHFT18L Champion	47752201001
Kit CHFT25L Champion	47752202001
Kit CHFT30L Champion	47752203001
Kit CHFT58L Champion	47752204001
Kit CHFT100L Champion	47752205001
Kit CHFT166L Champion	47752206001
Kit CHFT260L Champion	47752207001
Kit CHFT383L Champion	47752208001
Kit CHFT466L Champion	47752209001
Kit CHFT950L Champion	47752210001

## CORRECTION FACTORS

°C/BARG	4	5	6	7	8	9	10	11	12	13	14	15
25°C	0.63	0.75	0.88	1.00	1.00	1.00	1.00	1.14	1.14	1.14	1.25	1.25
30°C	0.63	0.75	0.88	1.00	1.00	1.00	1.00	1.14	1.14	1.14	1.25	1.25
35°C	0.63	0.75	0.88	1.00	1.00	1.00	1.00	1.14	1.14	1.14	1.25	1.25
40°C	0.63	0.66	0.77	0.88	0.88	0.88	0.88	1	1	1	1.11	1.11
45°C	0.63	0.54	0.63	0.72	0.72	0.72	0.72	0.81	0.81	0.81	0.9	0.9
50°C	0.63	0.39	0.45	0.52	0.52	0.52	0.52	0.58	0.58	0.58	0.65	0.65

# CH-PP SERIES PAINTING AIR FILTRATION

## At a glance...



**Operating Pressure**  
16 bar



**Flow Rate**  
0.1 - 108.33 m<sup>3</sup>/min



**Operating Temp. Range**  
1.5 - 65°C



**Pipe Size**  
1/2"

## Applications

- Chemical
- Petrochemical
- Paint
- General industrial applications
- Breathing air



CH-PP pro paint system is specifically designed for purifying compressed air from solid, liquid and partially gaseous components. Protecting air equipment in addition to providing clean air for worker health protection. PP pro paint system is easy for wall mount.

### Available modular combinations:

1. Comp. air for lower quality demands (down to 15 µm)
2. Comp. air for basic quality demands (down to 0,1 µm)
3. Comp. air for high quality demands (down to 0,01 µm)
4. Technical absolutely clean air (down to 0,1 µm, activated carbon)
5. Technical and breathable air
6. Compressed air for highest demands (all in one unit)

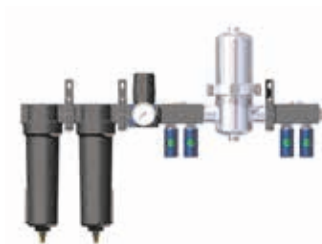





TYPE	PART NO	PIPE SIZE [inch]	FLOW RATE AT 7 BAR(G), 20 °C		DIMENSIONS			SEPARATOR CKL-PP	MICROFILTER M 0,1MM	MICROFILTER S 0,01MM	ACTIVE CARBON A	STERILE FILTER WITH ACTIVE CARBON SFA	ADSORPTION DRYER A-DRY 105	PRESSURE REGULATOR	QUICK COUPLING NO.
			[m³/min]	[cfm]	A [mm]	B [mm]	C [mm]								
CH-PP-107	CC1189591	1/2"	1.3	46	270	135	276	✓						✓	2
CH-PP-110	CC1189592	1/2"	2	71	270	135	345	✓						✓	2
CH-PP-207	CC1189593	1/2"	1.3	46	380	135	276	✓	✓					✓	2
CH-PP-210	CC1189594	1/2"	2	71	380	135	345	✓	✓					✓	2
CH-PP-307	CC1189595	1/2"	1.3	46	490	135	276	✓	✓	✓				✓	2
CH-PP-310	CC1189596	1/2"	2	71	490	135	345	✓	✓	✓				✓	2
CH-PP-407	CC1189597	1/2"	1.3	46	580	135	276		✓	✓	✓			✓	4
CH-PP-410	CC1189598	1/2"	2	71	580	135	345		✓	✓	✓			✓	4
CH-PP-507	CC1189599	1/2"	1.3	46	612	135	370		✓	✓		✓		✓	4
CH-PP-510	CC1189600	1/2"	2	71	612	135	440		✓	✓		✓		✓	4
CH-PP-607	CC1189601	1/2"	1.3	46	1150	335	917		✓	✓		✓	✓	✓	4
CH-PP-610	CC1189602	1/2"	2	71	1150	335	917		✓	✓		✓	✓	✓	4

#### CORRECTION FACTORS

OPERATING PRESSURE [bar]	2	3	4	5	6	7	8	9	10	11	12	13	14	15	16
OPERATING PRESSURE [psi]	29	44	58	72	87	100	115	130	145	160	174	189	203	218	232
CORRECTION FACTOR	0.38	0.50	0.63	0.75	0.88	1	1.13	1.25	1.38	1.50	1.63	1.75	1.88	2.00	2.13

0.1 MICRON MICROFILTER	FILTER ELEMENT TYPE	PART NO
	Filter Cartridge F007M	<b>223182</b>
	Filter Cartridge F010M	<b>223183</b>

0.1 MICRON FINEFILTER	FILTER ELEMENT TYPE	PART NO
	Filter Cartridge F007S	<b>223192</b>
	Filter Cartridge F010S	<b>223193</b>

0.1 MICRON A ACTIVATED CARBON	FILTER ELEMENT TYPE	PART NO
	Filter Cartridge F007A	<b>223212</b>
	Filter Cartridge F010A	<b>223213</b>

CKL-PP SEPARATOR	FILTER ELEMENT TYPE	PART NO
	Filter Cartridge F007-CKL-PP	<b>CC1189457</b>
	Filter Cartridge F010-CKL-PP	<b>CC1189458</b>

# CHB-AIR BREATHING AIR FILTER

## At a glance...



**Operating Pressure**  
16 bar



**Flow Rate**  
1.3 - 13 m<sup>3</sup>/min



**Operating Temp. Range**  
1.5 - 45°C



**Pipe Size**  
1/2 - 1/2"



## Applications

- Breathing air

CHB-AIR point of use filter set has been specifically developed for high efficient preparation of top quality breathing air. On request CHB-AIR filter set can be supplied with wall mounting brackets, pressure regulator and quick couplings.

## WARNING!

Breathing air filter set CHB-AIR is not declared as CO<sub>2</sub> and CO removal filter. Despite that CHB-AIR comprises filter element which can reduce CO content.



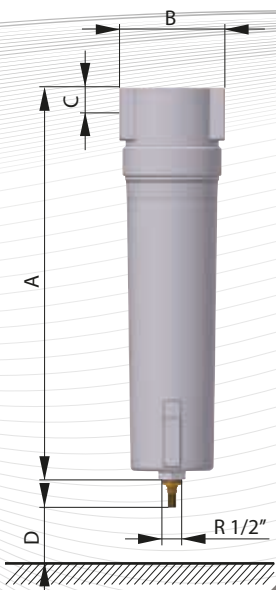

TYPE	PART NO	PIPE SIZE	FLOW RATE AT 7 BAR(G), 20 °C		DIMENSIONS				WEIGHT	FILTER ELEMENT TYPE
			[inch]	[m <sup>3</sup> /min]	[cfm]	A [mm]	B [mm]	C [mm]		
CHB-AIR 76	<b>CC1189704</b>	1/2"	1.3	46	187	88	20	60	1.41	F007 M/H2/A2
CHB-AIR 106	<b>CC1189705</b>	3/4"	2	70	257	88	20	80	1.8	F010 M/H2/A2
CHB-AIR 186	<b>CC1189706</b>	1"	3.3	116	263	125	32	100	4.71	F018 M/H2/A2
CHB-AIR 306	<b>CC1189707</b>	1"	5.58	197	363	125	32	120	6.6	F030 M/H2/A2
CHB-AIR 476	<b>CC1189708</b>	1 1/2"	8.5	300	461	125	32	140	8.4	F047 M/H2/A2
CHB-AIR 706	<b>CC1189709</b>	1 1/2"	13	459	640	125	32	160	11.7	F070 M/H2/A2

#### CORRECTION FACTORS

OPERATING PRESSURE [bar]	2	3	4	5	6	7	8	9	10	11	12	13	14	15	16
OPERATING PRESSURE [psi]	29	44	58	72	87	100	115	130	145	160	174	189	203	218	232
CORRECTION FACTOR	0.38	0.50	0.63	0.75	0.88	1	1.13	1.25	1.38	1.50	1.63	1.75	1.88	2.00	2.13

Prices are for complete set.

- Set includes 3 filter housings, 3 filter elements, 2 AOK16B condensate drains, 1 MCD drain and 1 PDI 16 differential pressure indicator.

FM	FILTER ELEMENT TYPE	PART NO
	Filter Cartridge F007M	<b>223182</b>
	Filter Cartridge F010M	<b>223183</b>
	Filter Cartridge F018M	<b>223184</b>
	Filter Cartridge F030M	<b>223185</b>
	Filter Cartridge F047M	<b>223186</b>
	Filter Cartridge F070M	<b>223187</b>

FH <sup>2</sup>	FILTER ELEMENT TYPE	PART NO
	Filter Cartridge F007H2	<b>CC1189441</b>
	Filter Cartridge F010H2	<b>CC1189442</b>
	Filter Cartridge F018H2	<b>CC1189443</b>
	Filter Cartridge F030H2	<b>CC1189454</b>
	Filter Cartridge F047H2	<b>CC1189455</b>
	Filter Cartridge F070H2	<b>CC1189456</b>

FA <sup>2</sup>	FILTER ELEMENT TYPE	PART NO
	Filter Cartridge F007A2	<b>CC1189354</b>
	Filter Cartridge F010A2	<b>CC1189434</b>
	Filter Cartridge F018A2	<b>CC1189435</b>
	Filter Cartridge F030A2	<b>CC1189437</b>
	Filter Cartridge F047A2	<b>CC1189438</b>
	Filter Cartridge F070A2	<b>CC1189439</b>



# CHB-AIR PLUS BREATHING AIR FILTER

### At a glance...



**Operating Pressure**  
16 bar



**Flow Rate**  
1.3 - 13 m<sup>3</sup>/min



**Operating Temp. Range**  
1.5 - 45°C



**Pipe Size**  
1/2"

### Applications

- Breathing air

CHB-AIR PLUS system has been specifically designed for applications where high quality breathing air and monitoring of breathing air supply are needed. CHB-AIR PLUS is a combination of our CHB-AIR PLUS 0106 breathing air filter set combined with gas concentration analysers, fitted with pressure regulator and quick couplings, all packed in a compact and robust casing.

Gas concentration analysers constantly monitor CO, CO<sub>2</sub> and O<sub>2</sub> concentrations and trigger an alarm if concentrations exceed the EN12021 and BS4275:1997 standard compliant values. In this way CHB-AIR PLUS can safely provide high quality breathing air for up to 5 people.

Small dimensions and low weight enable the use of CHB-AIR PLUS in many applications as it can be transported and set up with ease.

### Advantages

- High quality breathing air for up to 5 people
- Air quality monitoring (EN 12021, BS 4275:1997)
- Compact & light weight



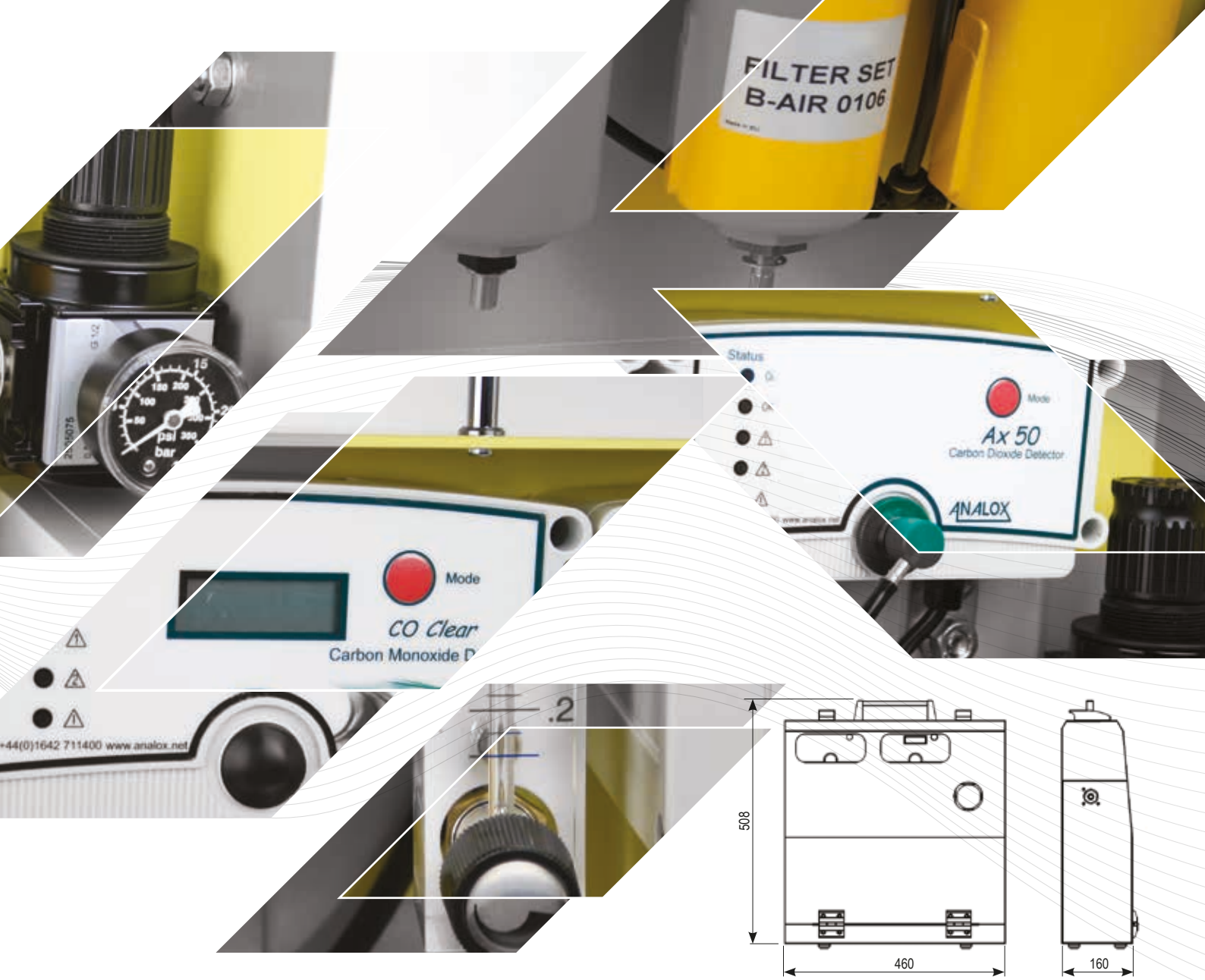

TYPE	PART NO	PIPE SIZE	FLOW RATE AT 7 BAR(G), 20 °C		DIMENSIONS			WEIGHT	FILTER ELEMENT TYPE
			[inch]	[m <sup>3</sup> /min]	[cfm]	A [mm]	B [mm]		
CHB-AIR PLUS	<b>CC1189710</b>	1/2"	2	71	508	460	160	12	

CORRECTION FACTORS															
OPERATING PRESSURE [bar]	2	3	4	5	6	7	8	9	10	11	12	13	14	15	16
OPERATING PRESSURE [psi]	29	44	58	72	87	100	115	130	145	160	174	189	203	218	232
CORRECTION FACTOR	0.38	0.50	0.63	0.75	0.88	1	1.13	1.25	1.38	1.50	1.63	1.75	1.88	2.00	2.13

Prices are for complete set.

FM	FILTER ELEMENT TYPE	PART NO
	Filter Cartridge F007M	<b>223182</b>

FH <sup>2</sup>	FILTER ELEMENT TYPE	PART NO
	Filter Cartridge F007H2	<b>CC1189441</b>

FA <sup>2</sup>	FILTER ELEMENT TYPE	PART NO
	Filter Cartridge F007A2	<b>CC1189354</b>

# CH-AIRWATT SERIES HEAT RECOVERY UNITS

## At a glance...



**Operating Pressure**  
1 - 16 bar



**Flow Rate**  
1.3 - 13 m<sup>3</sup>/min



**Operating Temp. Range**  
5 - 120°C



**Ambient Air Temp. Range**  
5 - 45°C

## Applications

- Heat recovery in oil lubricated rotary screw compressors

External heat recovery unit - CH-AIRWATT is designed to efficiently exploit the waste heat, generated during compression of air in rotary screw compressors.

Sometimes this represents more than 70% of energy consumed by the rotary screw compressor for the operation. This heat can then be used to heat domestic water or for heating, at almost no additional costs. This does not only help save money, but is also environmentally friendly. Unit has two separate piping systems with counter flow. Energy exchange from compressor to sanitary water occurs in plate heat exchanger, where compressor oil and sanitary water meets. Unit is controlled by thermostatic valve, which prevents compressor system getting to cold and damaging compressor.



OPERATING PRESSURE (OIL)	1 - 16 bar
MAXIMUM WATER PRESSURE	10 bar
OPERATING TEMPERATURE	5°C - 120°C
MAX. OUTLET WATER TEMPERATURE	70°C
PRESSURE DROP (OIL)	~ 100 mbar
AMBIENT TEMPERATURE	5°C - 45°C
WATER TEMPERATURE INDICATOR	Analogue mechanical

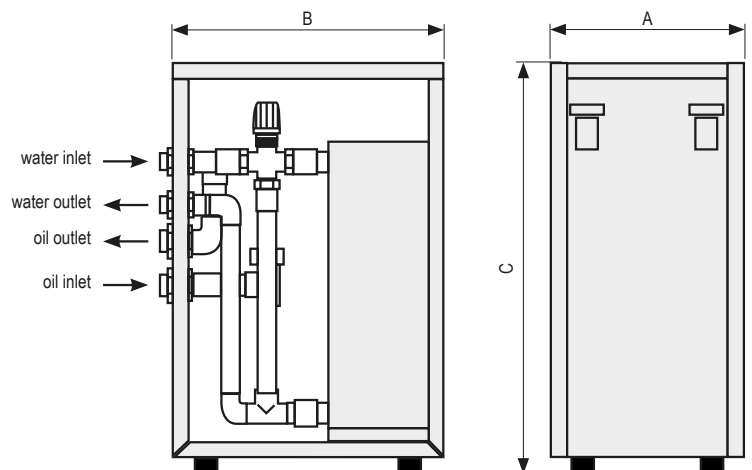

TYPE	PART NO	MOTOR POWER [kW]	HEAT CAPACITY [kW]	OIL CONNECTION [G]	WATER CONNECTION [G]	DIMENSIONS			WEIGHT [kg]
						A [mm]	B [mm]	C [mm]	
CH-AIRWATT 22	CC1189573	15 - 22	12 - 17.6	1 1/4"	1"	360	500	760	33
CH-AIRWATT 37	CC1189574	26 - 37	20.8 - 29.6	1 1/4"	1"	360	500	760	35
CH-AIRWATT 75	CC1189575	45 - 75	36 - 60	1 1/4"	1"	360	500	760	42
CH-AIRWATT 100	CC1189576	90 - 132	72 - 100	2"	2"	450	600	860	58



# VERTICAL AIR RECEIVERS

## At a glance...



**Operating Pressure**  
11 - 16 bar



**Capacity**  
100 - 10000l

Air receivers are an important part of the compressed air system, evening out peaks and troughs in air demand, minimising pulsations from piston compressors and protecting your air compressor from over frequent load/unload or start stop cycles.

VERTICAL TANKS <sup>1)</sup>	CODE	DIRECTIVE	SIZE [litre]	PRESSURE [bar]	AIR OUTLET [inch]
TANK 100L-11	CC1214969K	2014/29/EU	100	11	3/4
TANK 150L-11	CC1214973K	2014/29/EU	150	11	1
TANK 200L-11	CC1215044K	2014/29/EU	200	11	1
TANK 200L-11	CC1215045K	2014/29/EU	200	11	2
TANK 270L-11	220662K	2014/29/EU	270	11	1
TANK 270L-11	CC1215046K	2014/29/EU	270	11	2
TANK 500L-11	220663K	2014/29/EU	500	11	1
TANK 500L-11	CC1215047K	2014/29/EU	500	11	2
TANK 720L-11	220713K	2014/29/EU	720	11	1
TANK 720L-11	CC1215048K	2014/29/EU	720	11	2
TANK 900L-11	CC1120428K	2014/29/EU	900	11	1.5
TANK 900L-11	CC1215049K	2014/29/EU	900	11	2
TANK 1000L-12	220664K	2014/68/UE (PED)	1000	12	2
TANK 1500L-12	CC1120429K	2014/68/UE (PED)	1500	12	2
TANK 2000L-12	220665CK	2014/68/UE (PED)	2000	12	2
TANK 2000L-12	CC1215050K	2014/68/UE (PED)	2000	12	3
TANK 3000L-12	220668CK	2014/68/UE (PED)	3000	12	2
TANK 3000L-12	CC1215051K	2014/68/UE (PED)	3000	12	3
TANK 100L-16	CC1215052K	2014/29/EU	100	16	3/4
TANK 150L-16	CC1215055K	2014/29/EU	150	16	1
TANK 200L-15	CC1215056K	2014/29/EU	200	15	1
TANK 270L-16	CC1215057K	2014/29/EU	270	16	1
TANK 500L-16	CC1215058K	2014/29/EU	500	16	1
TANK 1000L-16	CC1215059K	2014/68/UE (PED)	1000	16	2
TANK 1500L-16	CC1215060K	2014/68/UE (PED)	1500	16	2
TANK 2000L-16	CC1109207K	2014/68/UE (PED)	2000	16	2
TANK 3000L-16	CC1215061K	2014/68/UE (PED)	3000	16	2
TANK 5000L-8	CC1215062K	2014/68/UE (PED)	5000	8	3
TANK 8000L-8	CC1215063K	2014/68/UE (PED)	8000	8	3
TANK 10000L-8	CC1215064K	2014/68/UE (PED)	10000	8	3
TANK 5000L-12	CC1215065K	2014/68/UE (PED)	5000	12	3
TANK 8000L-12	CC1215066K	2014/68/UE (PED)	8000	12	3
TANK 10000L-12	CC1215067K	2014/68/UE (PED)	10000	12	3

<sup>1)</sup> Including paint, support legs, pressure gauge, safety valve and inlet and outlet nozzles.

# GALVANISED VERTICAL AIR RECEIVERS

### At a glance...



**Operating Pressure**  
11 - 16 bar



**Capacity**  
100 - 3000l

Air receivers are an important part of the compressed air system, evening out peaks and troughs in air demand, minimising pulsations from piston compressors and protecting your air compressor from over frequent load/unload or start stop cycles.

VERTICAL TANKS <sup>1)</sup>	CODE	DIRECTIVE	SIZE [litre]	PRESSURE [bar]	AIR OUTLET [inch]
TANK 100L-11	CC1215039K	2014/29/EU	100	11	3/4
TANK 150L-11	CC1215040K	2014/29/EU	150	11	1
TANK 200L-11	CC1215041K	2014/29/EU	200	11	1
TANK 270L-11	CC1215042K	2014/29/EU	270	11	1
TANK 500L-11	CC1080281K	2014/29/EU	500	11	1
TANK 720L-11	CC1215043K	2014/29/EU	720	11	1
TANK 900L-11	CC1215094K	2014/29/EU	900	11	1 1/2
TANK 900L-11	CC1215095K	2014/29/EU	900	11	2
TANK 1000L-12	CC1103058K	2014/68/UE (PED)	1000	12	2
TANK 1500L-12	CC1215096K	2014/68/UE (PED)	1500	12	2
TANK 2000L-12	CC1103060K	2014/68/UE (PED)	2000	12	2
TANK 2000L-12	CC1215097K	2014/68/UE (PED)	2000	12	3
TANK 3000L-12	CC1215098K	2014/68/UE (PED)	3000	12	2
TANK 3000L-12	CC1215099K	2014/68/UE (PED)	3000	12	3
TANK 100L-16	CC1215100K	2014/29/EU	100	16	3/4
TANK 150L-16	CC1215101K	2014/29/EU	150	16	1
TANK 200L-15	CC1215102K	2014/29/EU	200	15	1
TANK 270L-16	CC1215103K	2014/29/EU	270	16	1
TANK 500L-16	CC1190548K	2014/29/EU	500	16	1
TANK 1000L-16	CC1190550K	2014/68/UE (PED)	1000	16	2
TANK 1500L-16	CC1215104K	2014/68/UE (PED)	1500	16	2
TANK 2000L-16	CC1215105K	2014/68/UE (PED)	2000	16	2
TANK 3000L-16	CC1215106K	2014/68/UE (PED)	3000	16	2

<sup>1)</sup> Including paint, support legs, pressure gauge, safety valve and inlet and outlet nozzles.





# CONDENSATE DRAINS

## IED SERIES ELECTRONIC CONDENSATE DRAINS



TECHNICAL DATA	IED	
VOLTAGE	230 VAC	115 VAC
FREQUENCY	50-60 Hz	50-60 Hz
INTERNAL FUSE	5 x 20 1A T	
POWER	10 VA	
OPERATING PRESSURE RANGE	0-16 bar [0-232 psi]	
DRAIN CAPACITY [AT 7 bar/101 PSI]	8 l/h at 7 bar [0,005 cfm at 101 psi]	
OPERATING TEMPERATURE RANGE	1.5-65 °C [35-149°F]	
INLET CONNECTION	G 1/2" parallel thread	
PROTECTION CLASS	IP54	
MASS [kg]	0.3	
OPERATING TEMPERATURE RANGE	1.5 to 65°C	
DIMENSIONS [L x B x H]	61 x 60 x 161 mm	
SERVICE NETWORK CONNECTION	-	-
ALARM OUTPUT	-	-
PART NUMBER	CC1182025	

## EMD SERIES ELECTRONIC CONDENSATE DRAINS



TECHNICAL DATA	EMD12 230 V
SERVICE NETWORK CONNECTION	-
ALARM OUTPUT	-
VOLTAGE	230 VAC, 50-60 Hz
INTERNAL FUSE	5 x 20 1A T
POWER	10 VA
OPERATING PRESS. RANGE	0-16 bar [0-232 psi]
DRAIN CAPACITY [AT 7 bar/101 PSI]	12 l/h [0.007cfm]
OPERATING TEMP. RANGE	1.5-65°C [35-149°F]
INLET CONNECTION	G 1/2"
OUTLET CONNECTION	Push connection for tube ø8
PROTECTION CLASS	IP54
MASS [kg]	0.55
DIMENSIONS A x B x C [mm]	133 x 76 x 147
PART NUMBER	CC1112242

## ECD-B SERIES ELECTRONIC CONDENSATE DRAINS



TECHNICAL DATA		ECD 15B	ECD 40B	ECD 90B	ECD 150B
VOLTAGE	115 VAC	115 V ± 10 %	115 V ± 10 %	115 V ± 10 %	115 V ± 10 %
	230 VAC	230 V ± 10 %	230 V ± 10 %	230 V ± 10 %	230 V ± 10 %
POWER	115 VAC	24 VA	24 VA	24 VA	24 VA
	230 VAC	24 VA	24 VA	24 VA	24 VA
FREQUENCY	50-60 Hz				
OPERATING PRESSURE	0-16 bar (0 - 232 psi)				
DRAIN CAPACITY [AT 7 bar/101 PSI]	15 l/h	40 l/h	90 l/h	150 l/h	
OPERATING TEMPERATURE RANGE	1.5 - 65 °C (35-149 °F)				
INLET CONNECTION	R 1/2"	R 1/2"	R 1/2"	R 1/2"	
OUTLET CONNECTION	R 1/8"	R 1/8"	R 1/8"	R 1/8"	
POWER INTERFACE	3 x 0.75 mm <sup>2</sup>	3 x 0.75 mm <sup>2</sup>	3 x 0.75 mm <sup>2</sup>	3 x 0.75 mm <sup>2</sup>	
PROTECTION CLASS	IP54	IP54	IP54	IP54	
MASS [kg]	0.9	0.9	1.05	1.15	
DIMENSIONS A x B x C [mm]	120 x 82 x 125	120 x 82 x 125	120 x 82 x 135	120 x 82 x 150	
PART NUMBER	CC1150763	CC1164401	CC1183827	CC1183828	

## SAC 160 SERIES TIME CONTROLLED CONDENSATE DRAINS



TECHNICAL DATA	SAC 160		SAC 160 cr	
	115V	230V	115V	230V
SUPPLY VOLTAGE	115V	230V	115V	230V
OPERATING TEMP. RANGE	1.5 - 65 °C [35-149 °F]		1.5 - 65 °C [35-149 °F]	
OPERATING PRESSURE	16 bar [232 psi]		16 bar [232 psi]	
PROTECTION CLASS	IP65		IP65	
COIL POWER	18VA (holding), 36 VA (inrush)		18VA (holding), 36 VA (inrush)	
MASS [cable + valve]	0.35 kg		0.35 kg	
TIME ON	0.5 s - 10 s		0.5 s - 10 s	
TIME OFF	0.5 min - 45 min		0.5 min - 45 min	
DRAIN CAPACITY [AT 7 bar]	95 l/h		95 l/h	
FLOW RATE Kvs	2.4 l/min		3.4 l/min	
INLET CONNECTION	R 1/2"		R 1/2"	
OUTLET CONNECTION	R 1/4"		R 1/4"	
DIMENSIONS L x B x H [mm]	77 x 79 x 93	87.5 x 90.5 x 123	77 x 79 x 93	87.5 x 90.5 x 123
MEDIUM	Air, water, oil		Agressive fluids	
OPTION STRAINER	Yes		No	
PART NUMBER	CC1032411		CC1183829	

## SAC 120 AUTOMATED CONDENSATE DRAINS



TECHNICAL DATA	
OPERATING TEMP. RANGE	1.5 - 65 °C [35-149 °F]
OPERATING PRESSURE	20 bar [290 psi]
MASS	0.6 kg
DISCHARGE CAPACITY [AT 7 bar/101 PSI]	167 l/h
INLET CONNECTION	G 1/2" (NPT option)
OUTLET CONNECTION	G 1/2" (NPT option)
DIMENSIONS A x B x C	135 x 110 x 130 mm
MEDIUM	Condensate (air, water, oil)
PART NUMBER	222394

### Recommendations

Install ball valve between pressure vessel and inlet connection. Install strainer element between pressure vessel and inlet connection. Install nipple with venting tube to avoid generation of air bubbles. Nipple is screwed on inlet connection.



## SAC 70 AUTOMATED CONDENSATE DRAIN



TECHNICAL DATA	
OPERATING TEMP. RANGE	1.5 - 65 °C [35-149 °F]
OPERATING PRESSURE	0 - 16 bar [0 - 232 psi]
MASS	0.04 kg
CONNECTION	G 1/2"
OUTLET CONNECTION	ø8
DIMENSIONS H x D	90 x ø38.5 mm
MEDIUM	Condensate (air, water, oil)
PART NUMBER	223120

## MCD MANUAL CONDENSATE DRAIN



TECHNICAL DATA		
OPERATING TEMP. RANGE	1.5 - 65 °C [35-149 °F]	
OPERATING PRESSURE	0-20 bar [290 psi]	
MASS	0.06 kg	
CONNECTION	G 1/2"	
DIMENSIONS	H	38.2 mm
	E	24.0 mm
MEDIUM	Condensate [air, water, oil]	
MATERIAL	Brass	
PART NUMBER	CC1183830	

# CH SERIES OIL/WATER SEPARATORS

### At a glance...



#### Capacity

2.5 - 60 m<sup>3</sup>/min



#### Outlet Connection

1/2" - 3/4"



#### Inlet Connection

1/2" - 2 x 3/4"

### Unrivalled performance and efficiency

Environmental regulations strictly prohibit the discharge of oily wastes and chemicals, including the condensate drained from a compressed air system. This mixture of oil and water is classified as hazardous industrial waste, and the discharge of untreated compressor condensate into foul sewers is prohibited.

Compressor condensate must be either collected or treated before disposal using an oil water separator. Oil water separators remove lubricants from compressed air condensate ensuring environmentally friendly disposal. Considering that compressor condensate consists of approximately 95% water, it makes financial sense to separate the oil from the condensate before disposing of waste. Untreated condensate disposal is costly as it is charged by volume.

Every end-user that operates a compressed air system should have a condensate waste management program in place, not only to abide by laws and regulations but also to practice environmental and ecological responsibility. Champion oil water separators are a reliable, efficient, cost-effective, and environmentally friendly solution for on-site discharge of condensate from air compressors.

### Modular design for enhanced performance

Modern industrial working environments present a host of challenges for effective and long-lasting oil water separation including ambient humidity and extreme temperatures, different coolant types, excessive operating hours, equipment age, compressor loading and residual oil.

To meet these challenges, Champion separators offer different sizes to match the customers needs. They feature adsorption media that withdraws and permanently adsorbs the lubricants.



### Features are your benefits

#### Pre-filter removes contaminants

No fouling and clogging

#### Meets compressor flow requirements

Up to 60 m<sup>3</sup>/min

#### Complies with environmental regulations

Minimised fluid disposal costs

#### Streamlined design

Reliable operation with reduced maintenance





## How it works

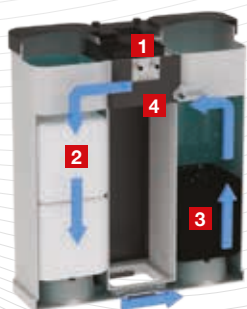

1. Oily water flows through the diffuser
2. First chamber, multiple Polypropylene media captures oil
3. Second chamber, Carbon media further removes oil
4. Clean water exits separator

## The responsible choice

By minimising the cost associated with the disposal of fluids, and keeping them out of the environment, Champion oil water separators help you to stay compliant with environmental regulations and avoid costly fines. The separator is also designed to operate with minimal maintenance or downtime, resulting in no mess or overflow.

Champion separators provide condensate discharge levels < 10 ppm at standard conditions.

## Guaranteed adsorption of a variety of coolants

Polypropylene and carbon media are effective on a big variety of polyalphaolefins lubricants and mineral oils available in the market.

## Multiple sizing options

Champion oil water separators come in 10 standard sizes, handling air flow from 2.5 to 60 m<sup>3</sup>/min. The media is designed to last up to 6 months at 8,000 hours/year of operation and up to 12 months at 4,000 hours/year. Each model has standardised, modular media bags.

### TECHNICAL DATA

OPERATING TEMP.RANGE	2 - 50°C
OPERATING MEDIA	Condensate (water - oil; Non aggressive) Not suitable for stabile condensate emulsion and polyglycol
DESIGN CONDITIONS	4 ppm Oil Carryover from compressor, 75% compressor loading, 20°C ambient and 70% RH
RESIDUAL OIL CONTENT	<15 ppm
SERVICE INTERVALS	When first of the following parameters appears: > 3 - 6 months if 8000 operating hours of compressor > 6 - 12 months if 4000 operating hours of compressor > when prefilter has oil built up

MODEL	CODE	CAPACITY [M <sup>3</sup> /MIN]	DIMENSIONS			WEIGHT [kg]
			[mm]	[mm]	[mm]	
CHS25	47716459001	2.5	590	200	245	6.5
CHS35	47716460001	3.5	590	200	245	7
CHS50	47716461001	5	645	510	170	9.5
CHS100	47716462001	10	830	700	206	17.5
CHS150	47716463001	15	830	700	206	20
CHS200	47716464001	20	830	700	206	22.5
CHS300	47716465001	30	1050	950	350	44.5
CHS400	47716466001	40	1050	950	350	50
CHS500	47716467001	50	1240	1065	410	65
CCHS600	47716468001	60	1240	1065	410	78

# INDUSTRIAL CHILLERS

## At a glance...

 Cooling Capacity  
0.8 - 365 kW

Contact the Champion Sales Team for more information, prices and brochure.

Champion can now offer a range of chillers and coolers including Water Chillers, Oil Chillers, Liquid Coolers and Air to Water Coolers

## The Range



### Water Chillers

**CHW 09 - 3652**

Cooling Capacity 1.1 - 365 kW

Especially designed for welders, inductors, food-packaging machinery, laser cutters, tooling machines, die-casting processes, molding and extruding processes of plastic materials, aerodynamic pumps and wine-making industry.

### Low Temperature Water Chillers

**CHG 08-1260**

Cooling Capacity 0.8 - 126 kW

The low temperature liquid water chillers were designed to meet the needs of the chemical and food industries, to process and preserve products at temperatures near or below 0°C and are finding new industrial uses every day.







### Liquid Coolers

**CHA 99 - 150**

Cooling Capacity: 1.3 - 150kW

Ideal for systems where an intermediate stage between the refrigerant circuit and the user one is necessary, equipped with pump and tank.

### Air to Water Coolers

**CHR 08 - 174**

Cooling Capacity 0.8 - 174 kW

Air water liquid coolers, equipped with pump and tank, are suitable for cooling welders and spot welders, spindle and for all industrial applications that require liquid cooling at a temperature not lower than ambient one. Utilising forced air from the fan it is able to supply the outlet water at 5°C higher than the ambient temperature



### Oil Chillers

**CHO 29 - 149**

Cooling Capacity: 2.9 - 14.9 kW

The CHO series line is entirely dedicated to the sector of remote control machinery or those with hydraulic cooling. These machines constitute the best solution for the cooling of precision tooling machinery in a simple and prompt way.